

Inductive Proximity Sensor

M18 Series

Dimension	M18 x1	M18 x1
Installation	Flush (shielded)	Flush (shielded)
Mounting distance Sn	5.0mm	5.0mm
Detect distance Sn	0...4.0mm	0...4.0mm

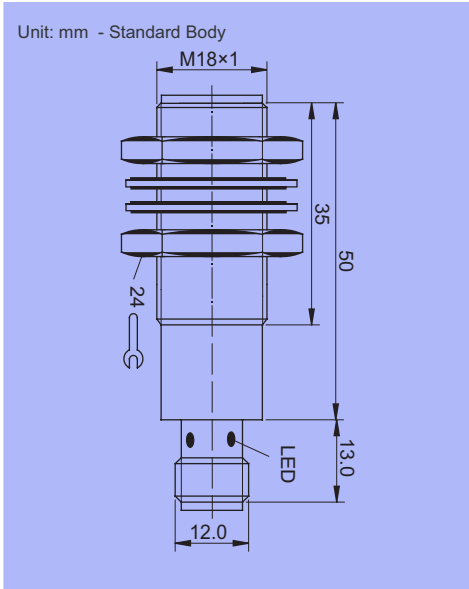
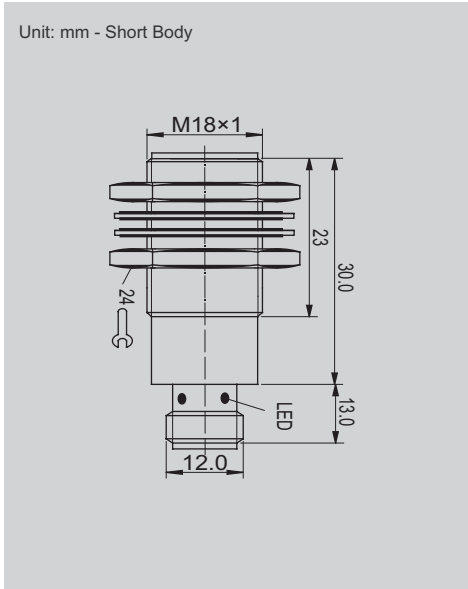

PNP	DC 3 wires	NO	DSS-CPS-POM18SB-5FM	DSS-CPS-POM18LB-5FM
		NC	DSS-CPS-PCM18SB-5FM	DSS-CPS-PCM18LB-5FM
NPN	DC 3 wires	NO	DSS-CPS-NOM18SB-5FM	DSS-CPS-NOM18LB-5FM
		NC	DSS-CPS-NCM18SB-5FM	DSS-CPS-NCM18LB-5FM

Rated operational voltage (DC/AC)	24V DC	24V DC
Supply voltage (DC/AC)	10-30V DC	10-30V DC
Voltage drop	≤ 2.0V	≤ 2.0V
Rated insulation voltage	≥ 20M Ω	≥ 20M Ω
Load current capacity (DC/AC)	200mA	200mA
Off-state current (NPN/PNP)	≤ 15mA	≤ 10mA
Leak current	≤ 20 μA	≤ 20 μA
Against polarity reversal	YES	YES
Short circuit protected	YES	YES
Load capacity	≤ 1μF	≤ 1μF

Repeated accuracy	≤ 5%	≤ 5%
Ambient temperature range	-25...+70°C	-25...+70°C
Frequency (DC 3/2wires / AC 2 wires)	700Hz/400Hz	700Hz/400Hz
Function indication	Red LED Indicator	Red LED Indicator

IP ratings	IP67	IP67
Housing material	Nickle plate brass	Nickle plate brass
Material of sensing face	ABS	ABS
Plug-in connector	M12 3/4 Wire	M12 3/4 Wire
Approvals	CE	CE

Normally Open (NO):
When metal is within proximity to the sensor, the circuit will close and the indicating LED light will be ON.

Normally Closed (NC):
When metal is within proximity to the sensor, the circuit will open and the indicating LED light will be OFF.